



# EC500-KH Series

CM238  
QM175



### ► Features

- Supports DDR4 SODIMM up to 32GB
- Three independent displays: 1 VGA + 1 DVI/HDMI + 1 HDMI/DP
- Rugged and Fanless Embedded System
- Rich I/O connectivity: 2 GbE, 4 COM, 4 USB 3.0, 2 USB 2.0, 1 CFast
- Supports 2 Mini PCIe and 1 M.2 slots
- Operating Temperature: -20 to 60°C, -40 to 70°C (optional)



### ► Panel

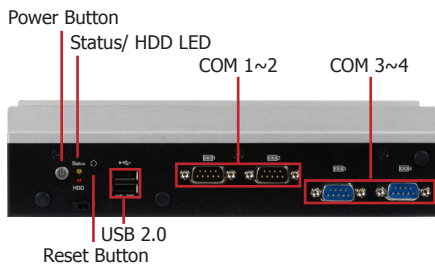

Front View

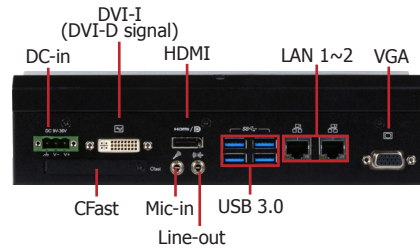

Rear View

### ► Dimensions

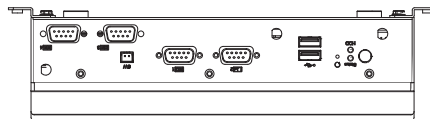

Front View

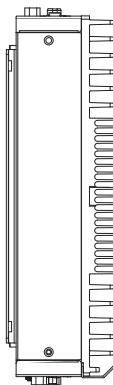

Left View

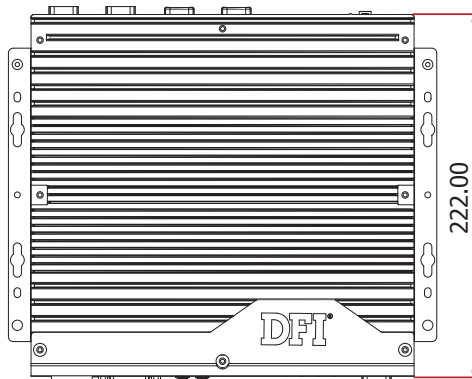

Rear View

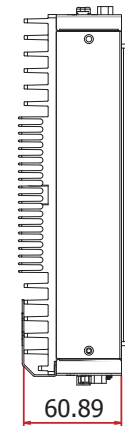

Right View

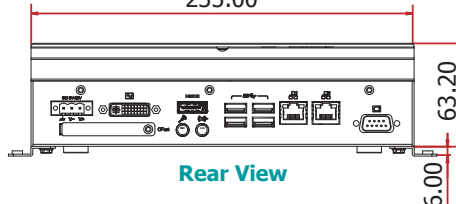

## ► Specifications

<b>SYSTEM</b>	<b>Processor</b>	7th Generation Intel® Core™ Processors, BGA 1440 Intel® Xeon® Processor E3-1535M v6, Quad Core, 8M Cache, 3.1GHz (4.2GHz), 45W Intel® Core™ i7-7820EQ Processor, Quad Core, 8M Cache, 3.0GHz (3.7GHz), 45W Intel® Core™ i5-7440EQ Processor, Quad Core, 6M Cache, 2.9GHz (3.6GHz), 45W Intel® Core™ i5-7442EQ Processor, Quad Core, 6M Cache, 2.1GHz (2.9GHz), 25W Intel® Core™ i3-7100E Processor, Dual Core, 3M Cache, 2.9GHz, 35W Intel® Core™ i3-7102E Processor, Dual Core, 3M Cache, 2.1GHz, 25W	
	<b>Chipset</b>	Intel® CM238 Chipset	Intel® QM175 Chipset
	<b>Memory</b>	Two 260-pin SODIMM up to 32GB (CM238 supports ECC) Dual Channel DDR4 2400MHz	
	<b>BIOS</b>	Insyde SPI 128Mbit	
<b>GRAPHICS</b>	<b>Controller</b>	Intel® HD Graphics	
	<b>Feature</b>	OpenGL up to 5.0, DirectX 11, OpenCL 2.1 HW Decode: HEVC/H.265, H.264, M/JPEG, MPEG2, VC1/WMV9, VP8 (8-bit), VP9 (10-bit) HW Encode: HEVC/H.265, M/JPEG, MPEG2, VP8	
	<b>Display</b>	1 x VGA 1 x HDMI/DVI (DVI-D signal) (DVI available upon request) 1 x HDMI/DP++ (DP++ available upon request)	VGA: resolution up to 1920x1200 @ 60Hz DVI: resolution up to 2560x1600 @ 60Hz HDMI: resolution up to 4096x2160 @ 24Hz DP++: resolution up to 4096x2304 @ 60Hz
	<b>Triple Displays</b>	VGA + HDMI/DVI (DVI-D signal) + HDMI/DP++	
<b>STORAGE</b>	<b>Internal</b>	1 x 2.5" SATA 3.0 Drive Bay (RAID) 1 x CFast Socket	
<b>EXPANSION</b>	<b>Interface</b>	1 x Full-size Mini PCIe with micro SIM socket (PCIe/USB) 1 x Full-size Mini PCIe with micro SIM socket (USB) 1 x M.2 M Key 2280 (PCIe x4) (QM175 only)	
<b>ETHERNET</b>	<b>Controller</b>	1 x Intel® I211AT PCIe (10/100/1000Mbps) 1 x Intel® I219LM with iAMT11.0 PCIe (10/100/1000Mbps) (only Core i7/i5 supports iAMT)	
<b>LED</b>	<b>Indicators</b>	1 x Power LED 1 x Status LED 1 x HDD LED	
<b>FRONT I/O</b>	<b>Serial</b>	2 x RS-232/422/485 (DB-9) (RS-232 with power) 2 x RS-232/422/485 (DB-9)	
	<b>USB</b>	2 x USB 2.0 (type A)	
	<b>Buttons</b>	1 x Power Button 1 x Reset Button	
	<b>Wi-Fi Antenna</b>	4 x Antenna Hole	
<b>REAR I/O</b>	<b>Ethernet</b>	2 x GbE (RJ-45)	
	<b>USB</b>	4 x USB 3.0 (type A)	
	<b>Display</b>	1 x VGA 1 x HDMI/DVI (DVI-D signal) (DVI available upon request) 1 x HDMI/DP++ (DP++ available upon request)	
	<b>Audio</b>	1 x Line-out 1 x Mic-in (available upon request)	
<b>WATCHDOG TIMER</b>	<b>Output &amp; Interval</b>	System Reset, Programmable via Software from 1 to 255 Seconds	
<b>SECURITY</b>	<b>TPM</b>	TPM 2.0	
<b>POWER</b>	<b>Type</b>	Wide Range 9~36V	
	<b>Connector</b>	3-pole Terminal Block	2-pin Power Extension Switch Connector
<b>OS SUPPORT</b>		Windows 10 IoT Enterprise LTSB 64 Bit	Linux (available upon request)
<b>MECHANISM</b>	<b>Construction</b>	Metal + Aluminum	
	<b>Mounting</b>	Wall Mount	
	<b>Dimensions (W x H x D)</b>	TBD	
	<b>Weight</b>	TBD	
<b>ENVIRONMENT</b>	<b>Operating Temperature</b>	0 to 50°C (HDD) -20 to 60°C (SSD) -40 to 70°C (optional)	
	<b>Storage Temperature</b>	-20 to 85°C	
	<b>Relative Humidity</b>	5 to 95% RH (non-condensing)	
<b>STANDARDS AND CERTIFICATIONS</b>	<b>Shock</b>	Half sine wave 3G, 11ms, 3 shock per axis	
	<b>Vibration</b>	IEC68-2-64	
	<b>Certification</b>	CE, FCC Class A	

Wall Mounting

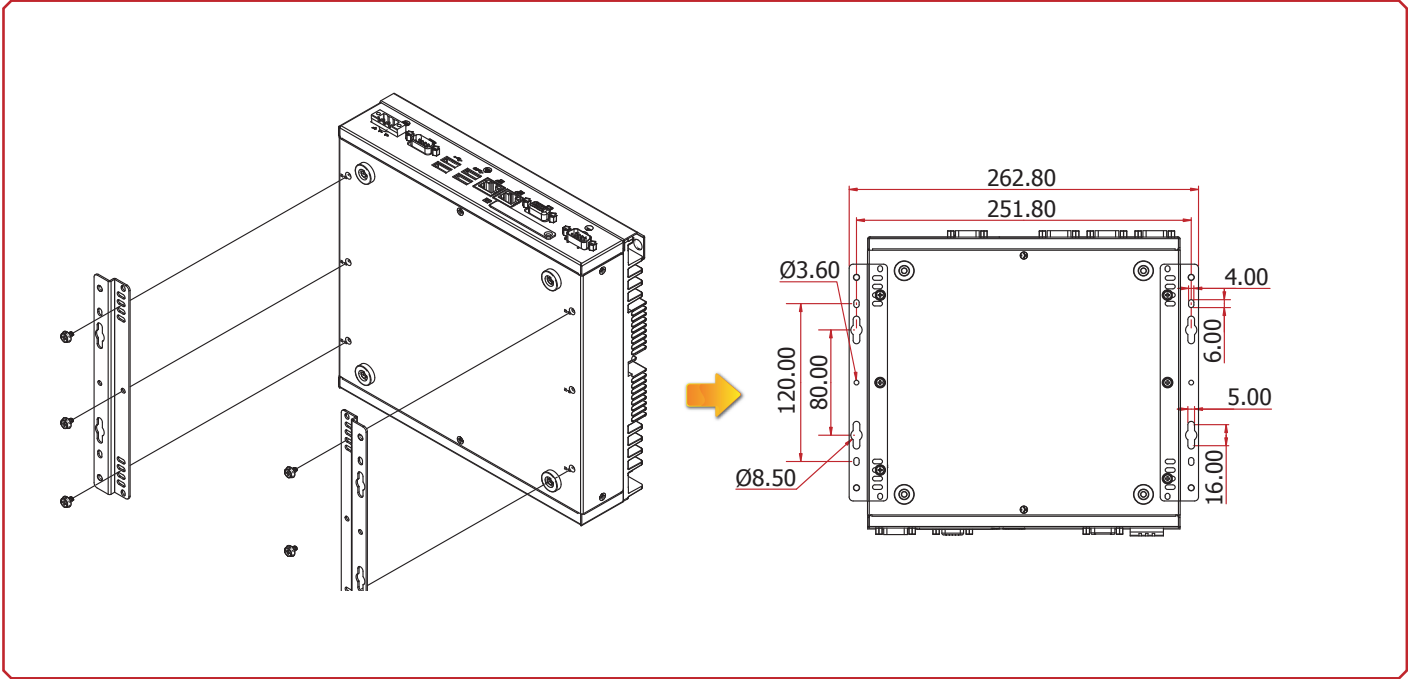

### ► Ordering Information

Model Name	Part Number	Description
EC500-KH	750-EC5002-100G	Fanless, KH263-QM175, I3-7102E, 4 COM, 6 USB, 2 LAN, -40 to +70C . DC 9~36V input, F/G SYSTEM RoHS

### ► Optional Items

Optional Items	Part Number	Description
<b>SO-DIMM</b>	785-RSOD416G	SODIMM, DDR4 Module, 16GB, RoHS
	785-RSOD48G	SODIMM, DDR4 Module, 8GB, RoHS
	785-RSOD44G	SODIMM, DDR4 Module, 4GB, RoHS
<b>M.2 SSD</b>	785-M2PCIE128G	M.2 PCIE x4, 128GB RoHS
	785-M2PCIE256G	M.2 PCIE x4, 256GB RoHS
	785-M2PCIE512G	M.2 PCIE x4, 512GB RoHS
<b>mSATA SSD</b>	85-MSATAH32G	mSATA,32GB MLC FULL SIZE RoHS
	85-MSATAH64G	mSATA,64GB MLC FULL SIZE RoHS
	85-MSATAH128G	mSATA,128GB MLC FULL SIZE RoHS
	85-MSATAH256G	mSATA,256GB MLC FULL SIZE RoHS
	85-MSATAH512G	mSATA,512GB MLC FULL SIZE RoHS
<b>Wi-Fi/BT Kit</b>	612-WPEQ26-000G	MINI-CARD 802.11ac/a/b/g/n+BT, 2T2R, WPEQ-261ACN(BT), SPARKLAN
<b>Power Cord</b>	785-PWRD	Power Cord, Standards (USA/EUR/CH/UK), 1.8m, RoHS
<b>Power Adapter</b>	671-110002-100G	100W, 12V, Level 6, RoHS
	671-110003-100G	120W, 19V, Level 6, RoHS
	671-112005-100G	120W, 24V, Level 6, Wide Temp, RoHS
	671-116003-000G	160W, 19V, Level 6, RoHS
<b>Wall Mount</b>	761-EC5410-000G	Wall Mount Kit, RoHS

### ► Packing List

• 1 EC500-KH Series system unit
• 1 Extend power switch cable
• 1 terminal block 3pole for DC input
• 1 cable with 2 wire stripped and tinned to DC jack